

EX095

Nora



Assembly instructions

Montageanleitung • Montagevejledning



60 cm



1+



2



5h



571 x 432 x 166 cm

Good advice and tips

- Ⓒ 1. Take all components from the pallet and place them on the ground
2. Compare with components list – is everything there?
3. Be at all times precise when measuring
4. Unpack one component at a time and assemble it
5. Usage of a water-level will increase precision
6. Fall protection is the very last thing to be installed – along with the producer's label

Ⓒ **Ein paar gute Ratschläge und Tipps**

1. Alle Bauteile von der Palette nehmen und auf den Boden legen.
2. Anhand der Bauteileliste überprüfen, ob alle Teile vorhanden sind
3. Beim Abmessen generell präzise arbeiten
4. Ein Bauteil nach dem anderen auspacken und montieren
5. Die Benutzung einer Wasserwaage erleichtert die Montage
6. Die Fallschutzunterlage wird erst ganz zum Schluss verlegt – dann, wenn das Produzentenetikett angebracht wird

Ⓒ **Gode råd og vejledning**

1. Tag komponenterne af pallen og læg dem på jorden
2. Check efter komponentlisten om alle er med
3. Vær omhyggelig med afstande generelt
4. Pak én komponent ud af gangen og gør denne færdig
5. Vær omhyggelig med brug af vatterpas
6. Faldunderlag etableres til allersidst sammen med påsætning af mærkning med producent

Clearance and safety surfaces

Platzbedarf und Fallschutzunterlage • Pladshensyn og faldunderlag

Safety surface in accordance with EN 1176

Fallschutzunterlag gemäß EN 1176

Faldunderlag i overensstemmelse med EN 1176

	Height • Höhe • Højde	(*) Area • Fläche • Areal
Total	≤60 cm	41,0 m ²

(*) Areas are accurately calculated values which are difficult to achieve in practice.
Die Flächen haben die genaue berechneten Werte, aber sind schwer in Praxis zu erreichen.
Arealerne er nøjagtigt beregnede værdier, som er vanskelige at opnå i praksis.

Scale • Maßstab • Målstok 1:100

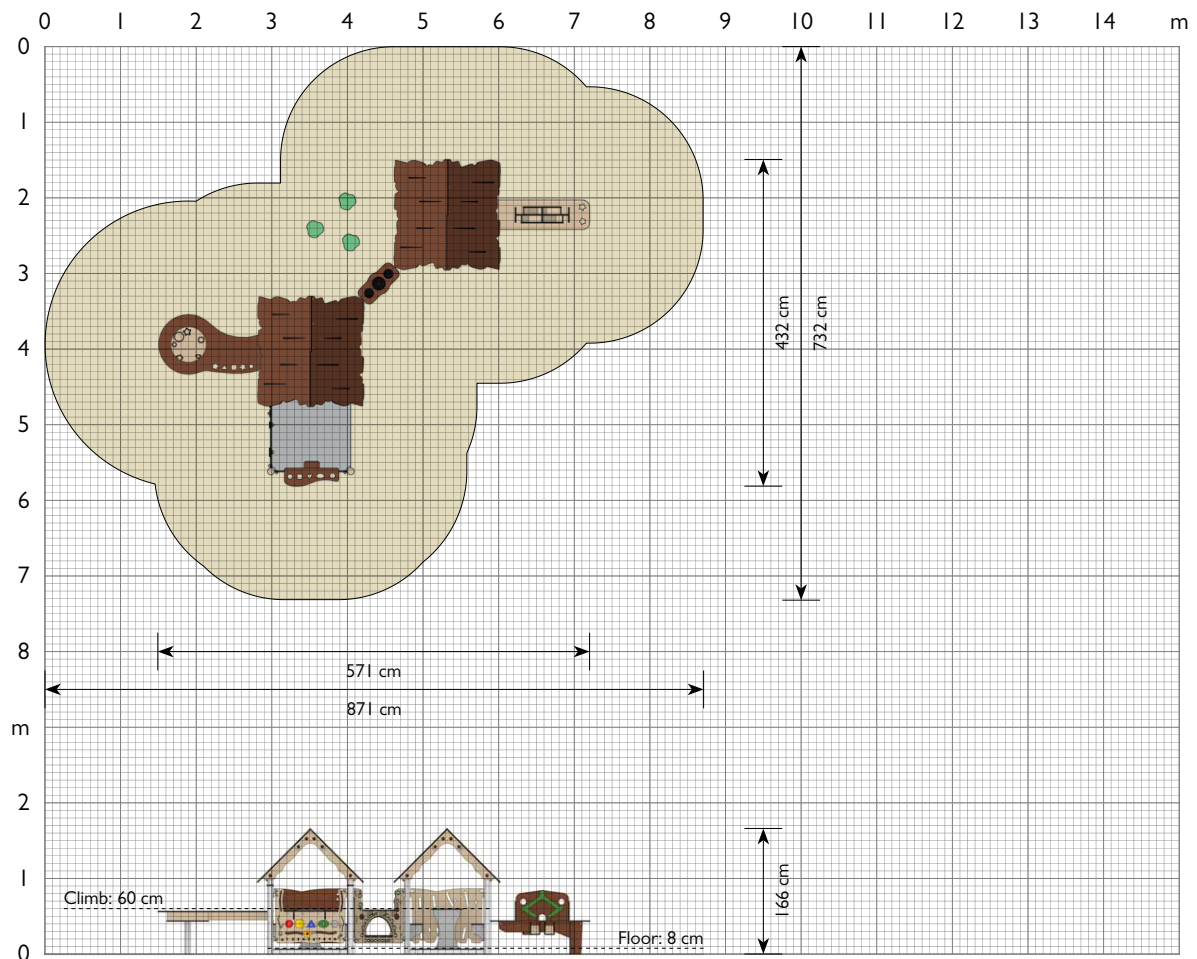

Components overview

Bauteileübersicht • Komponentoversigt

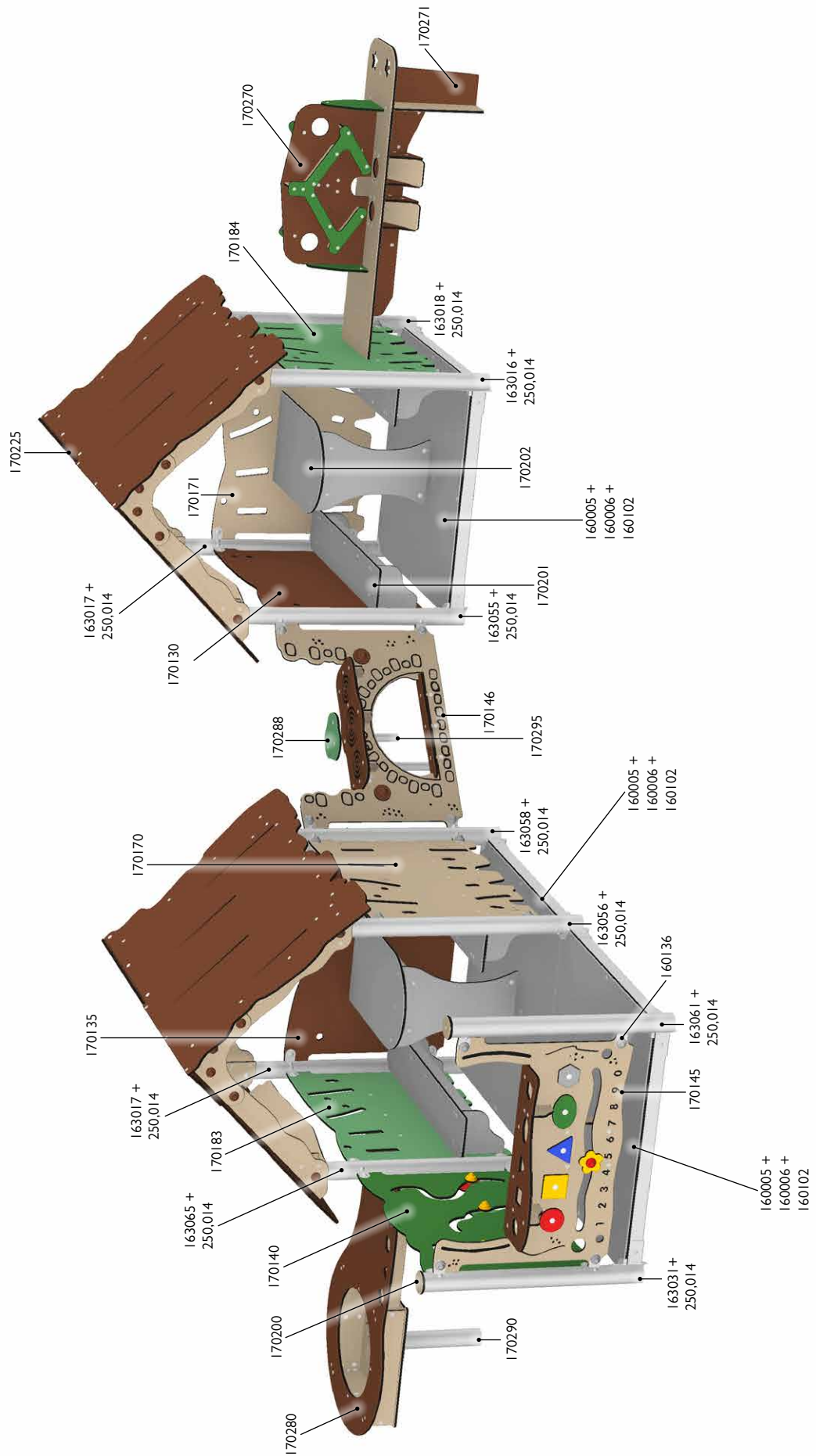

Site preparation

Vorbereitung • Pladsforberedelse

All holes with no other specified dimensions are 25x25 cm.
 Alle Löcher ohne anderen angegebenen Abmessungen sind 25x25 cm.
 Alle huller uden anden angivet dimension er 25x25 cm.

Digging depths • Grøbtefyer • Grøvedybder:

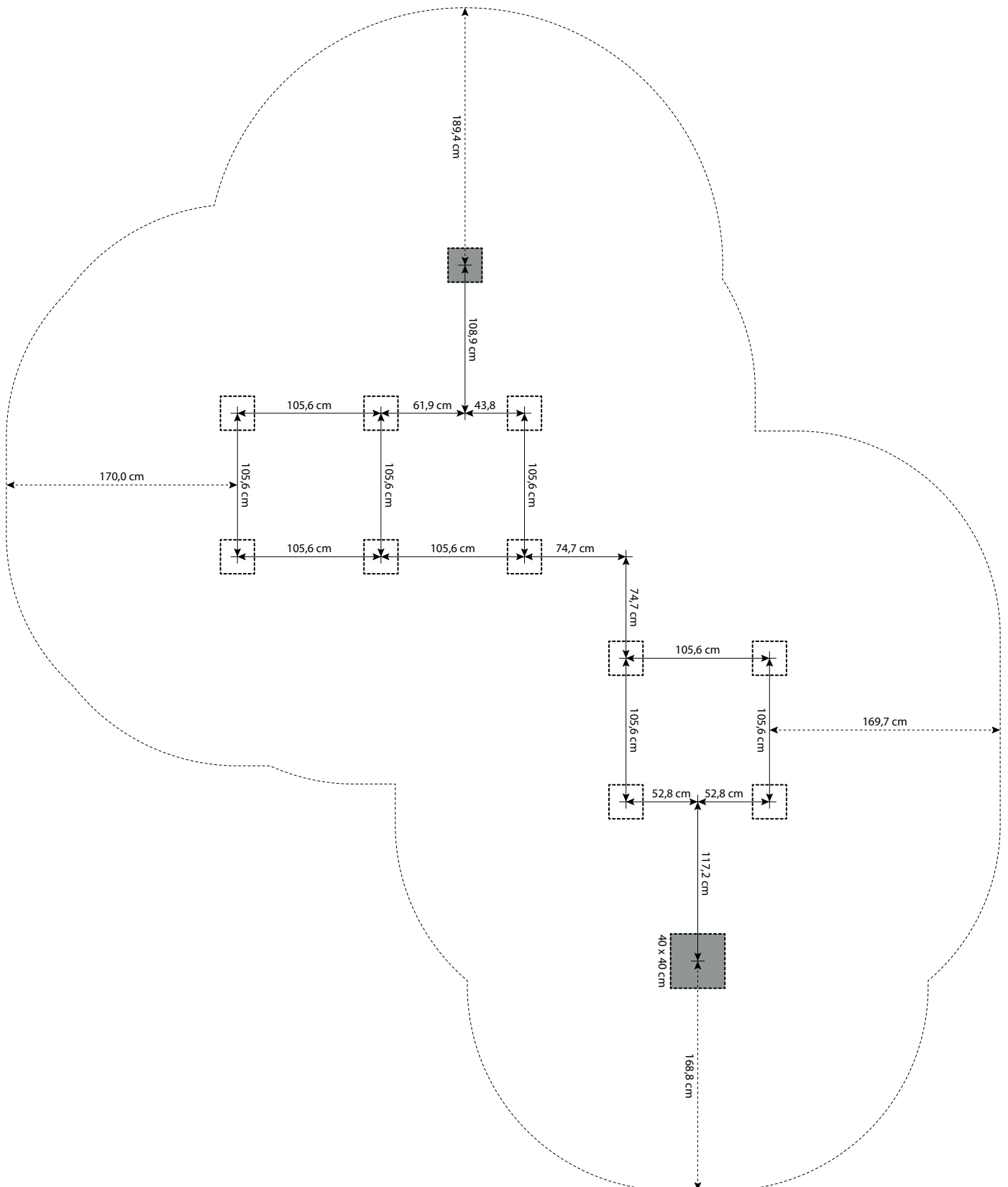
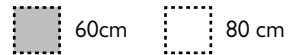

Assembly

Montage • Montage

The numbers in the boxes refer to the relevant installation principles in separate compendium.
Die Zahlen in die Boxen referieren zu relevanten Montageprinzipien in separaten Kompendium.
Numrene i boksene henviser til relevante montageprincipper i separat kompendium.

Important! Mount the floor to the posts before placing them all in the holes.
Wichtig! Montieren Sie den Boden an die Pfosten, bevor die Pfosten in der Bohrungen platziert werden.
Viktigt! Monter gulvet på stolperne før det hele plasseres i hullerne.

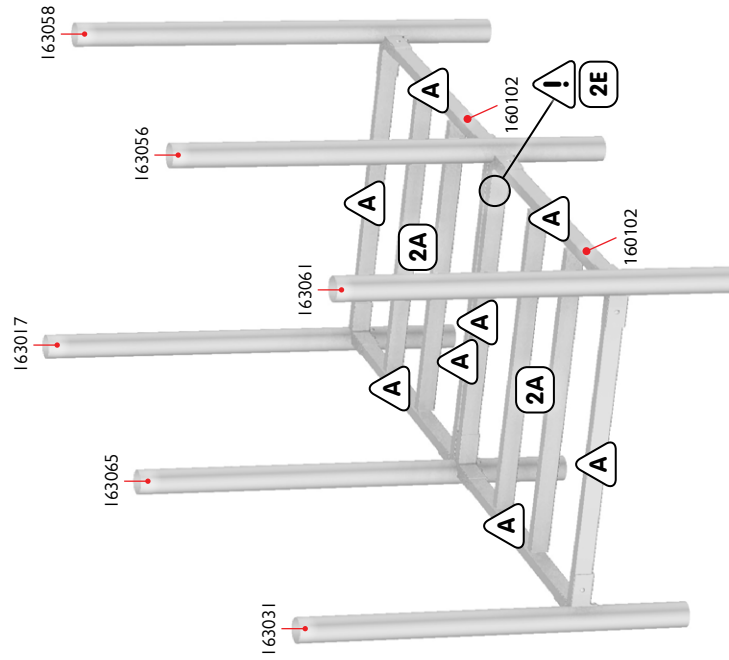
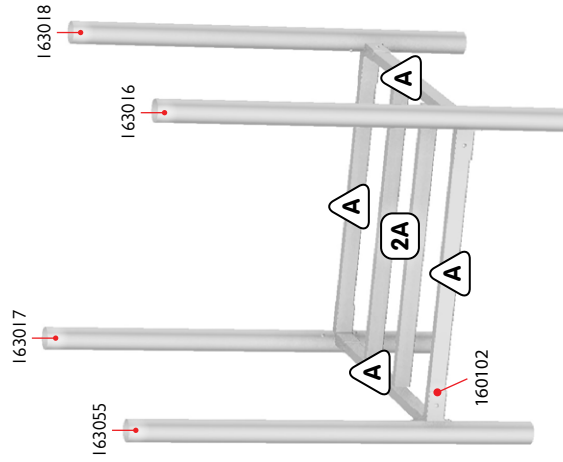

Assembly

Montage • Montage

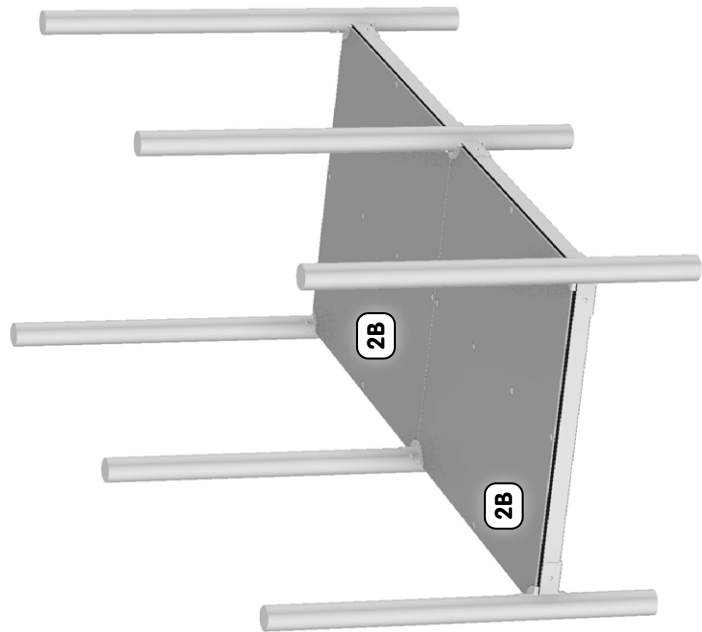
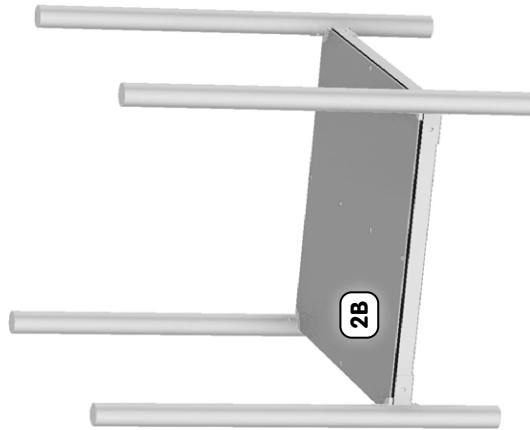

Assembly

Montage • Montage

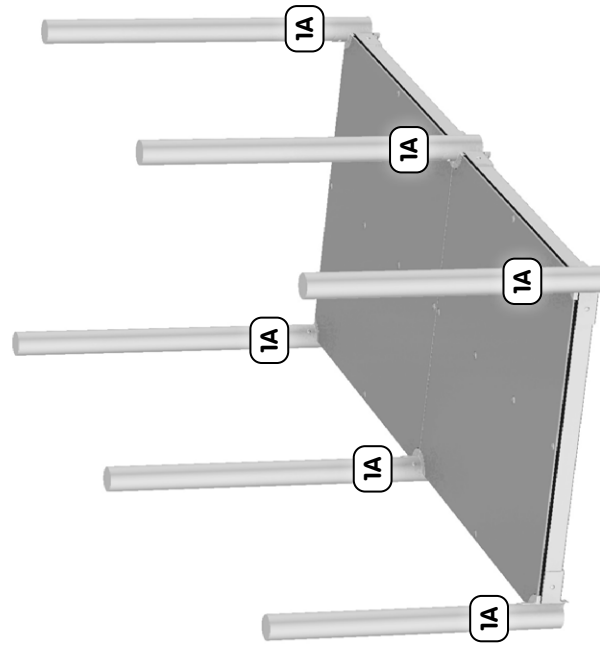
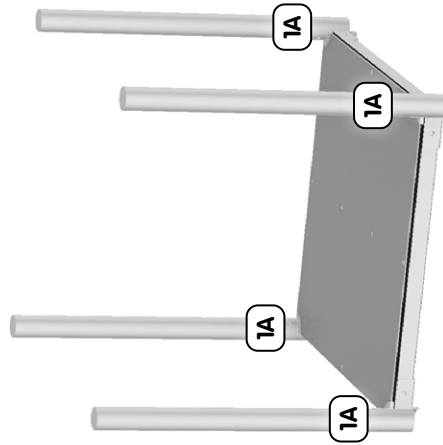

Assembly

Montage • Montage



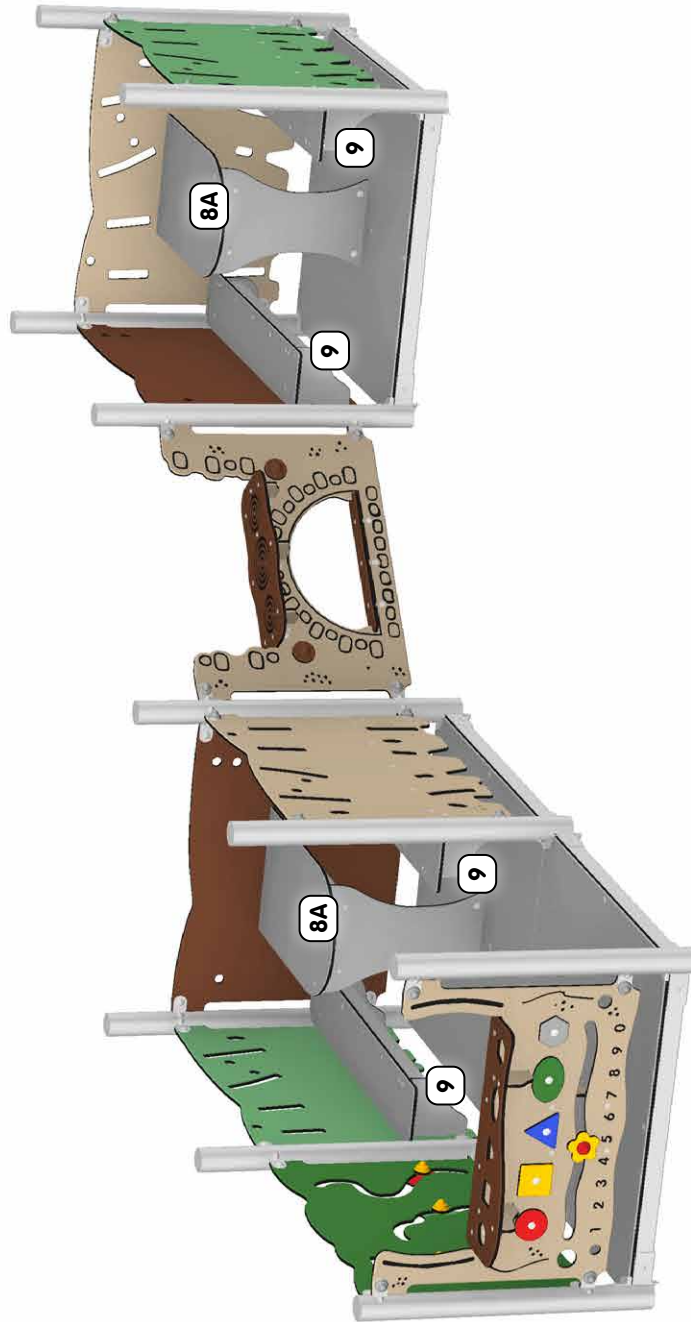

Assembly

Montage • Montage

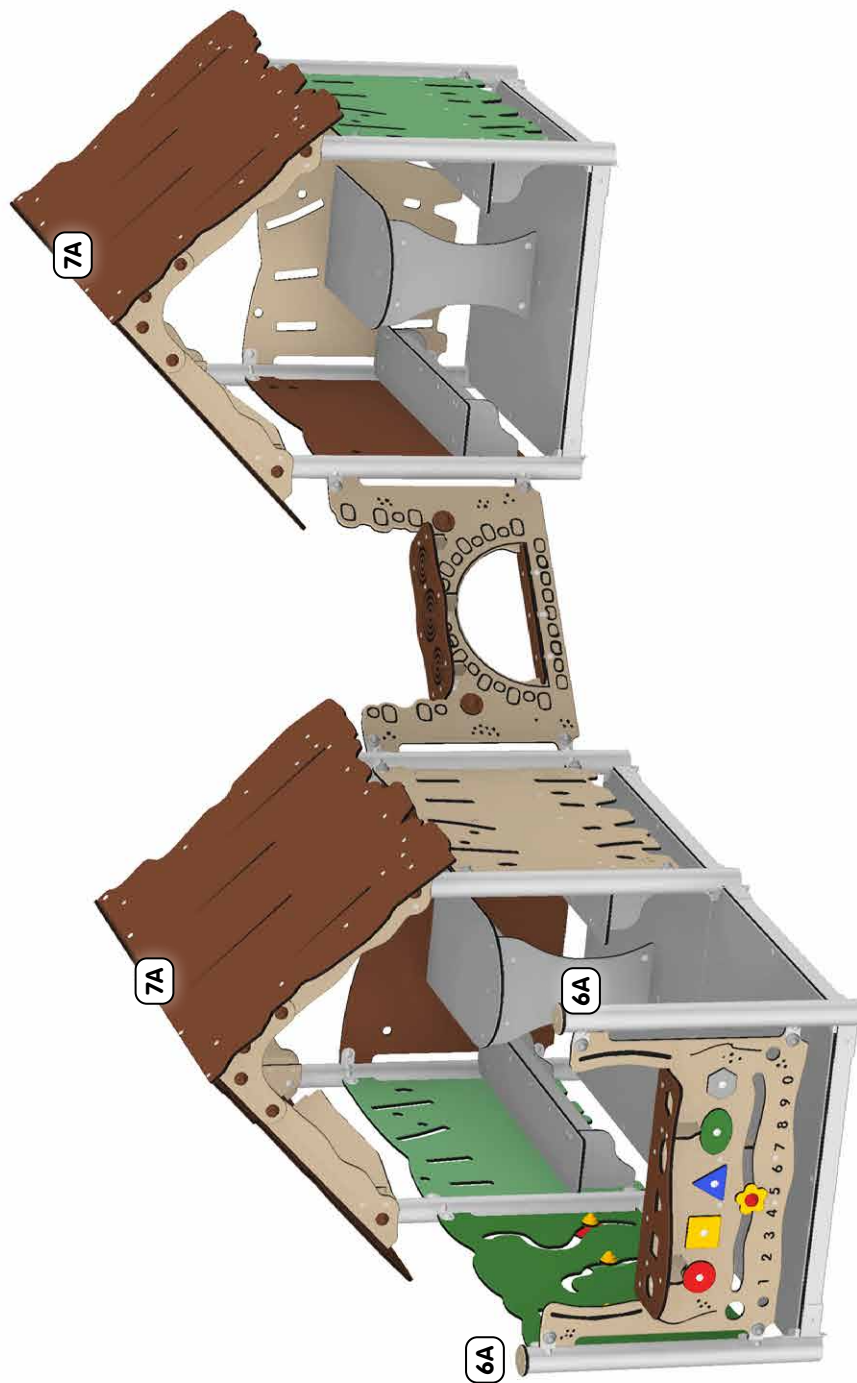

Assembly

Montage • Montage

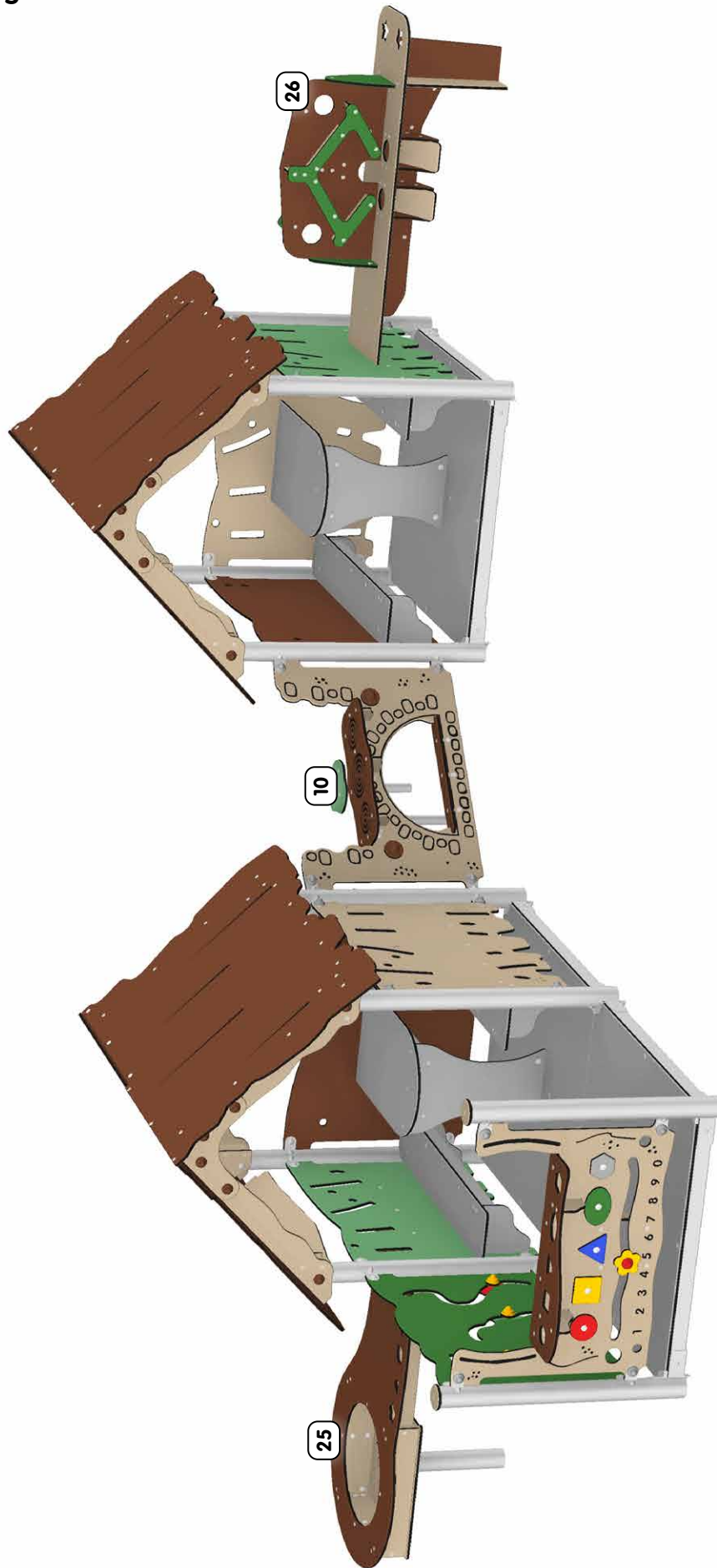

Assembly

Montage • Montage

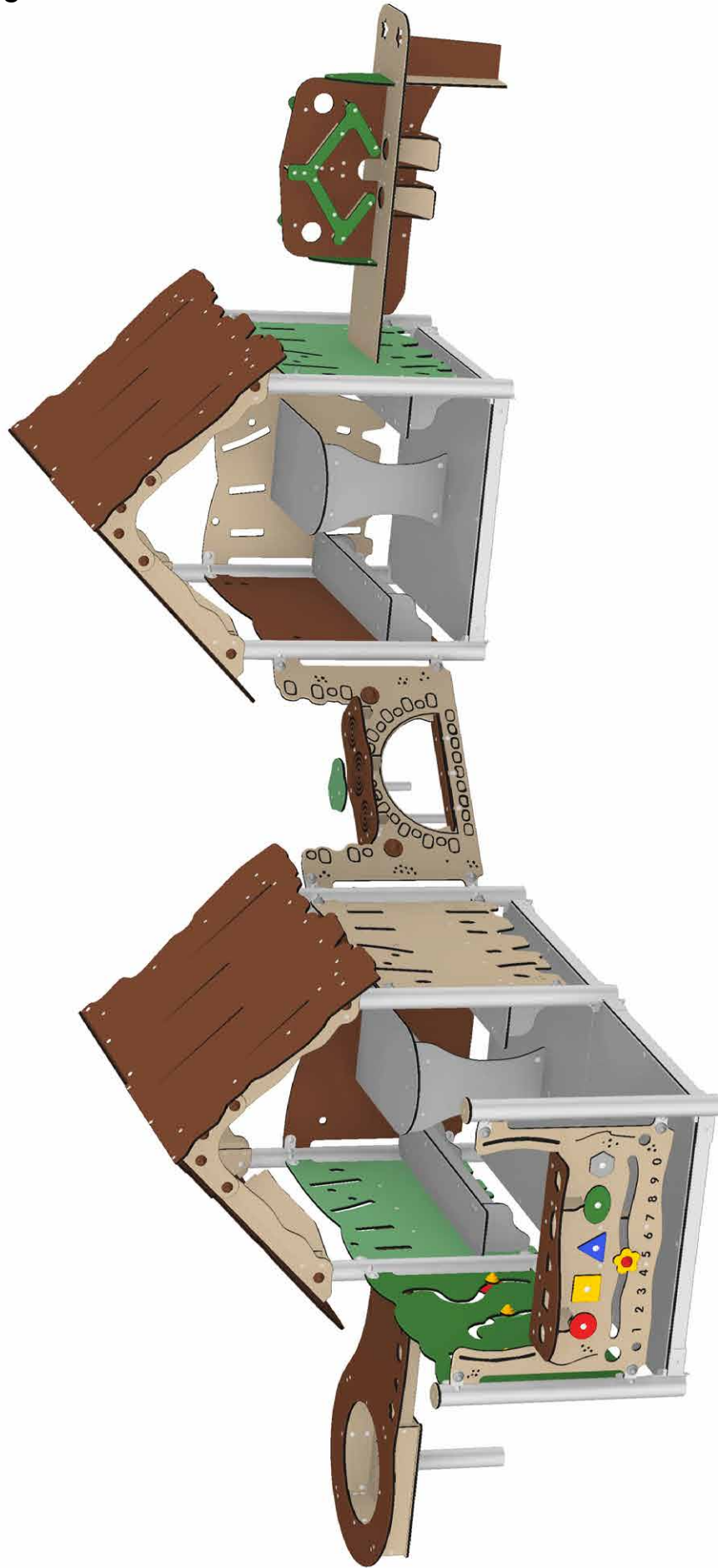

Ready
Fertig • Færdig